

MaxMotion

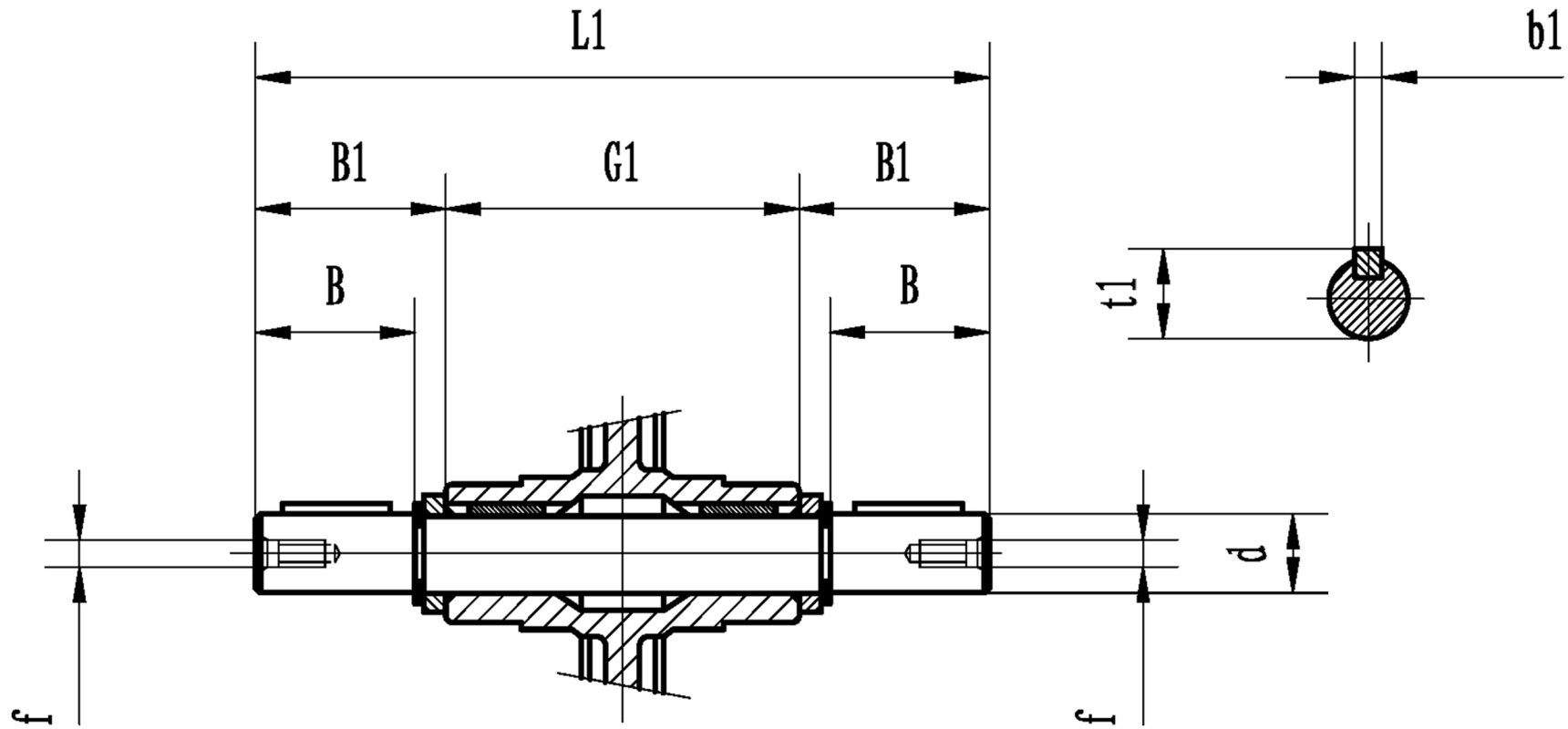

Customer is responsible in determining that MEP product will fit/perform suitably in the intended application

Version: 1HAN

Revised: 30-04-2020

SIZE	B	d	f	L1	B1	b1	G1	t1
63	50	25h6	M10	219	53.5	8	112	28

MMR63-DOUBLE OUTPUT SHAFT