

MaxMotion

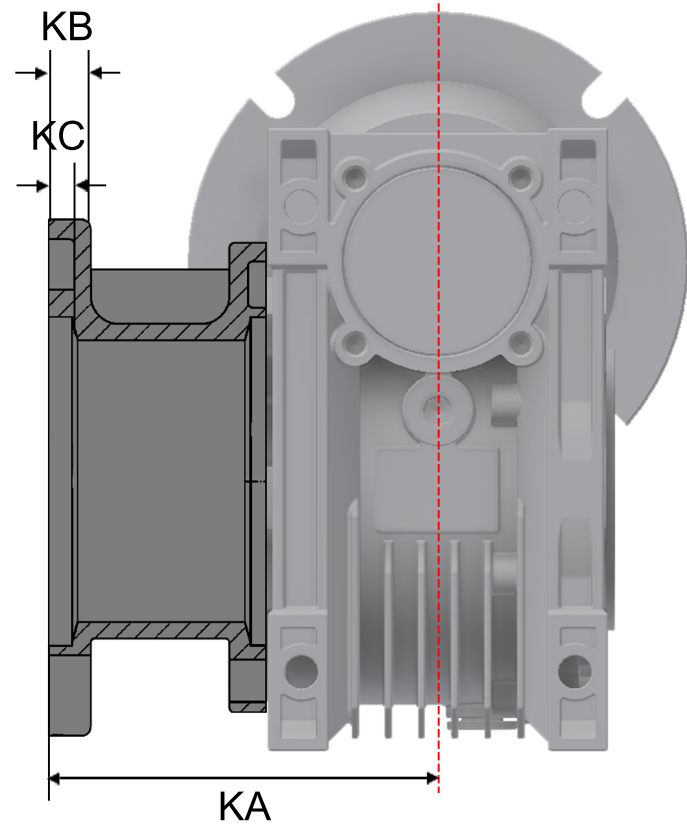
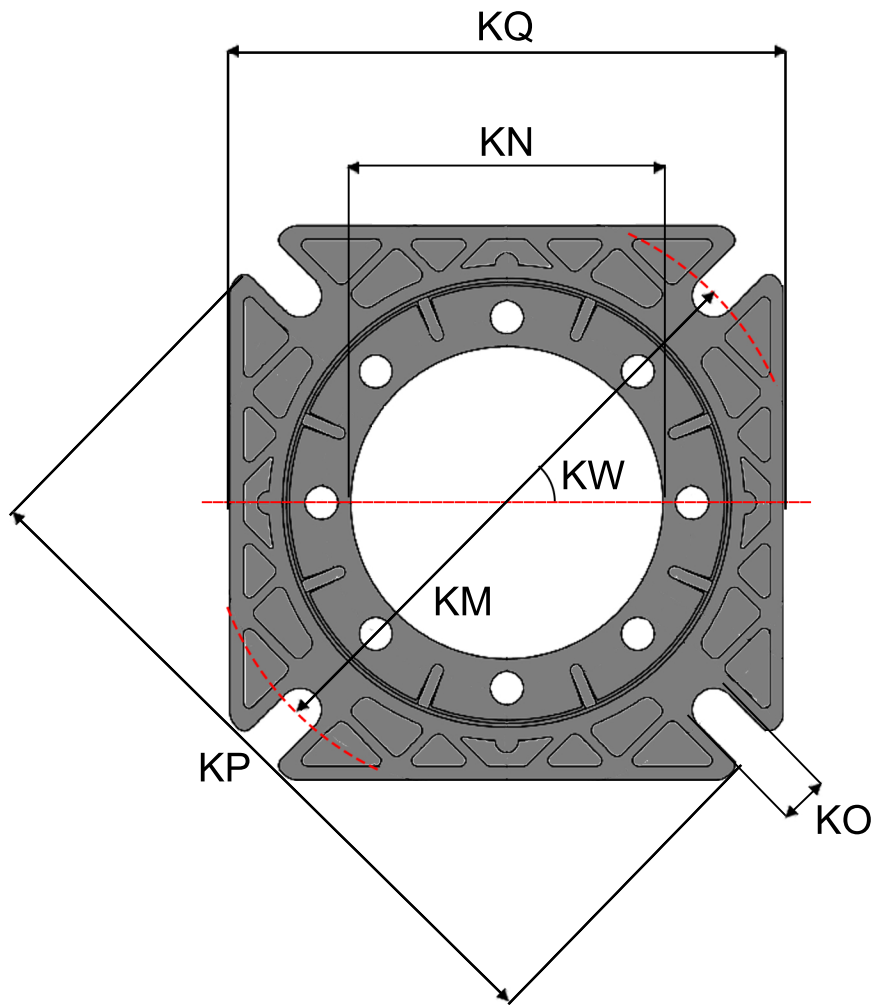

Customer is responsible in determining that MEP product will fit/perform suitably in the intended application

Version: 1HAN

Revised: 30-04-2020

SIZE	KA	KB	KC	KN	KM	KO	KP	KQ	KW
63	82	10	6	130	165	11(n°4)	180	142	45°

MMR63-FLANGE