

MaxMotion

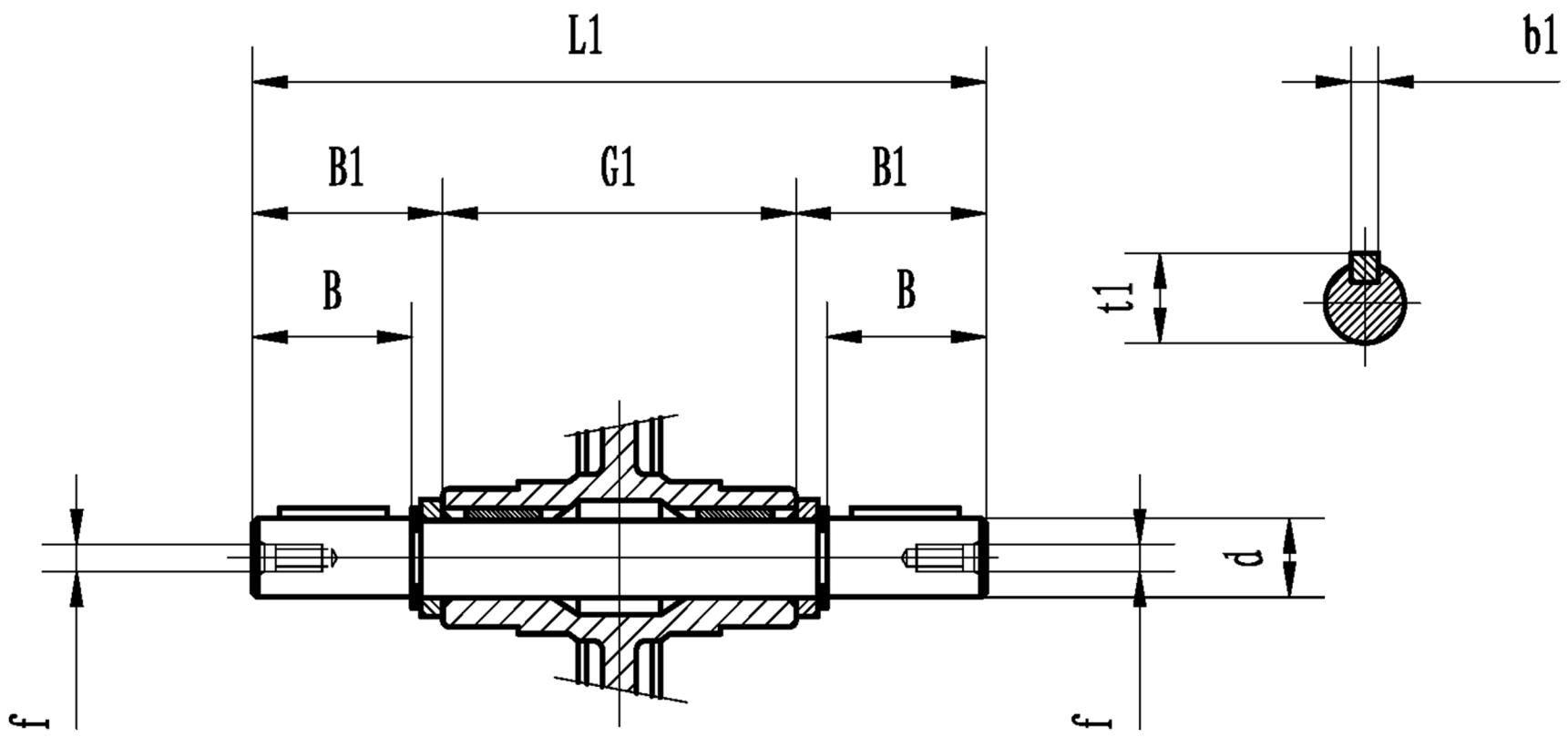

Customer is responsible in determining that MEP product will fit/perform suitably in the intended application

Version: 1HAN

Revised: 04-11-2020

SIZE	B	d	f	L1	B1	b1	G1	t1
50	50	25.4	3/8-16UNC	202.2	53.5	6.35	94	28.15

MRS50-DOUBLE OUTPUT SHAFT