



**PERFORMANCE DATA SHEET
NEMA PREMIUM NR CAN NEMA 12 - 12**

Catalogue #: MPSP-104TLNV

HP	kW	Voltage	S.F. @ 60Hz	Efficiency	Power Factor	Frame	Design	L.R. Amps
1	0,75	575	1,15	85,5%	0,644	143TC	B	12

60 Hz								
FLA							Code	F.L. RPM
208	230	416	460	480	575	600		
/	/	/	/	/	1,36	/	K	1740

50 Hz								
FLA			S.F. @ 50Hz	Efficiency	Power Factor	Code	F.L. RPM	
190	380	415						
/	/	/	/	/	/	/	/	

Wgt. Lbs	PH	Duty	Insul. Class	Amb.	Elevation	Temp. Rise° C
36	3	Cont.	F	40°C	1000M (3300 Ft)	25

% Efficiency		% Power Factor		Torque		Winding Resist. Ω	Safe Cold Start (Secs)
Full Load:	85,5%	Full Load:	0,64	Full Load Ft/Lbs	3,0		
3/4 Load:	84,2%	3/4 Load:	0,60	Locked Rotor %	300		
1/2 Load:	78,0%	1/2 Load:	0,47	Break Down %	310	19	12

Rotor Inertia Wk2 Lb-Ft2	Max Load Inertia Wk2 Lb-Ft2	Shaft Material	Frame Material	DE Bracket Type	ODE Bracket Type	Enclosure	NEMA Rating	Lead Wire Size
0,04	8,5	304SS	Stainless Steel			TENV	IP69K	16AWG

Ball Bearings		Grease	Mount Type	Orientation	Paint	Sound Pressure @ 3FT	Sound Power
DE	ODE						
6205	6205	Sealed Bearings	Foot	Horizontal	-	61	70

Inverter Duty. Motor meets MG1 parts 31.4.4.2	Constant Torque Range	Variable Torque Range	Constant HP RPM
	10:1	20:1	2700

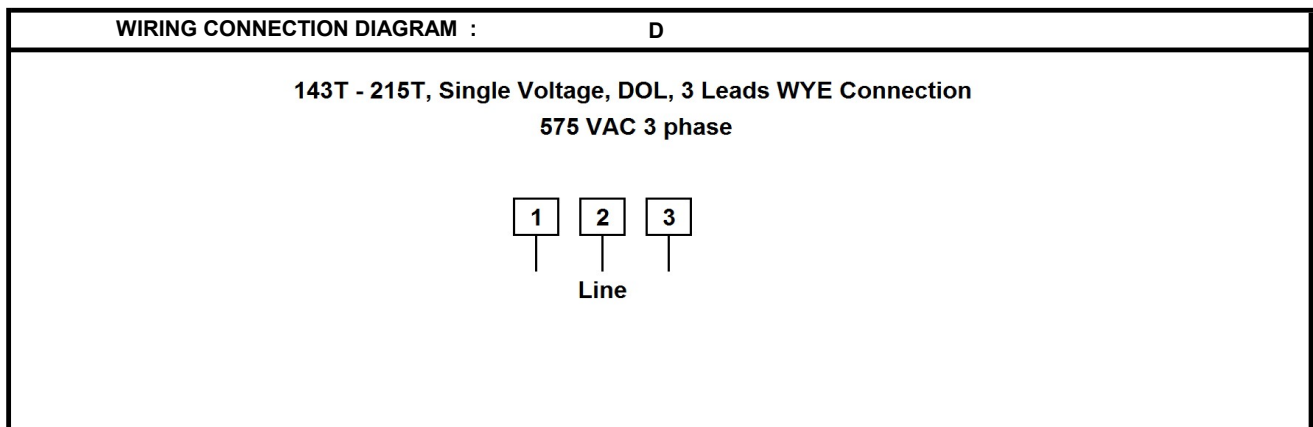

Date: 2024-01-29
 Customer: _____
 Contact: _____
 Submittee: J.C. Lavallée

Catalogue #: **MPSP-104TLNV**

NEMA PREMIUM NR CAN NEMA 12 - 12										
HP	VAC	RPM	Enclosure	Frame	Frequency	Design	Poles	LR Code Letter	Insulation Class	Temp. Rise °C
1	575	1740	TENV	143TC	60	B	4	K	F	25
	0Hz	6Hz	15Hz	30Hz	45Hz	60Hz	75Hz	90Hz	105Hz	120Hz
Amps	1,36	1,36	1,36	1,36	1,36	1,36	1,36	1,36	1,36	1,36
RPM	0	174	435	870	1305	1740	2175	2610	3045	3480
Torq ft.lb	2,41	2,41	3,02	3,02	3,02	3,02	2,41	2,01	1,72	1,51
Peak Tq ft.lb	3,85	7,70	7,70	7,70	7,70	7,70	6,16	5,13	4,40	3,85
HP	0	0,1	0,3	0,5	0,8	1,0	1,0	1,0	1,0	1,0
	Locked Rotor	Pull-Up	Breakdown	Rated Load	Idle	Duty	S. F.	Ambient	Elevation	dBA @ 1M
Speed (RPM)	0,0	756	1440	1740	1800	Continuous	1,15	40°C	3,300 ft	61
Current (Amps)	12,0	10,2	7,1	1,4	0,6	VFD Rating: Meets MG1 parts 31.4.4.2				
Torque (ft-lbs)	9,1	7,7	9,4	3,0	0,0	CT	10:1	VT	20:1	

Motor Speed Data

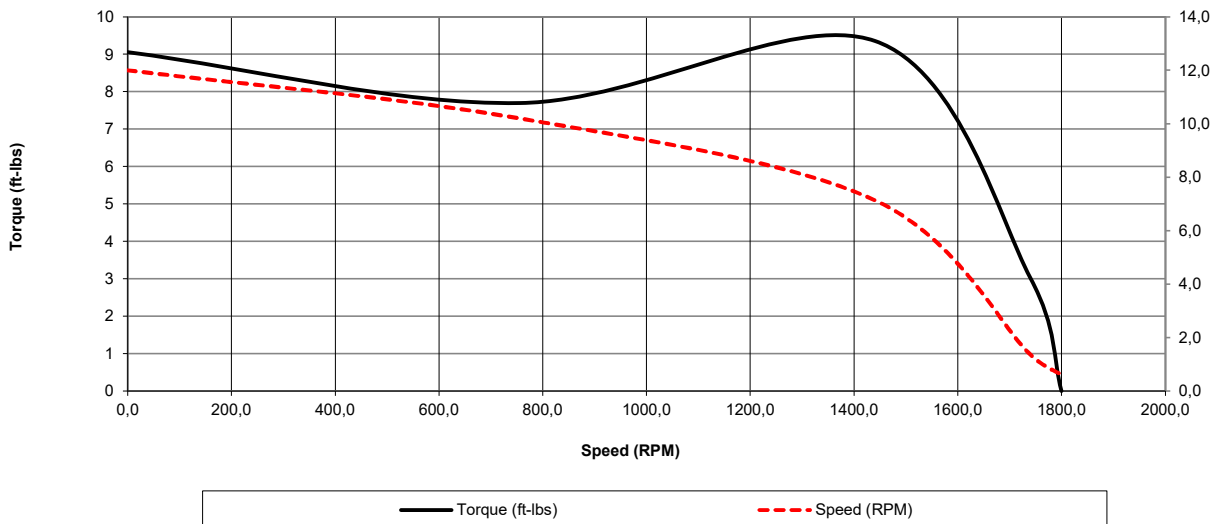

Motor Torque Capability vs RPM

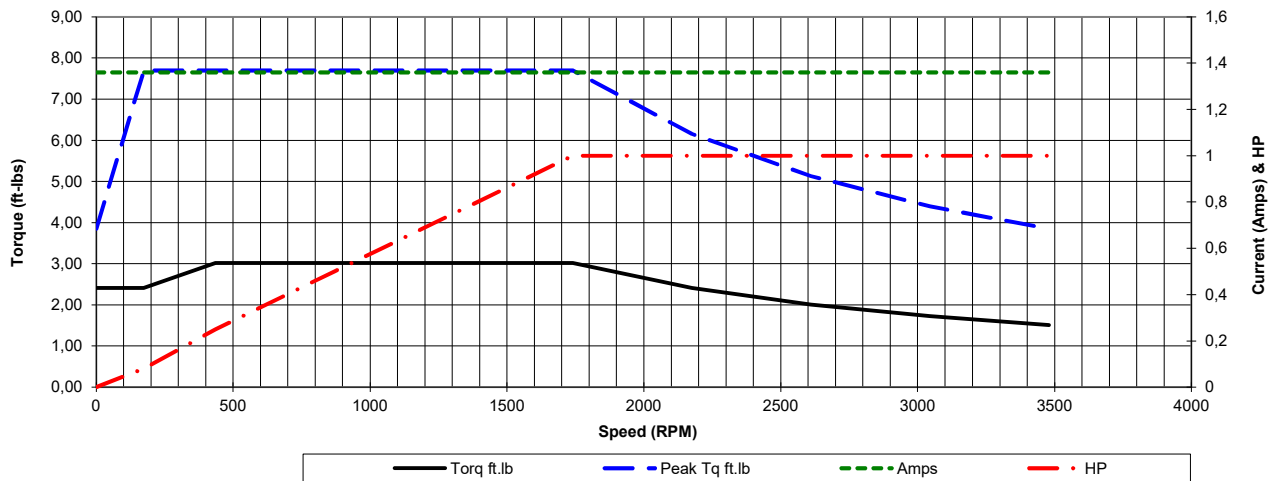

Date: 2024-01-29
 Customer: _____
 Contact: _____
 Submittee: J.C. Lavallée

Catalogue #: MPSP-104TLNV

NEMA PREMIUM NR CAN NEMA 12 - 12										
HP	VAC	RPM	Enclosure	Frame	Frequency	Design	Poles	LR Code Letter	Insulation Class	Temp. Rise °C
1	575	1740	TENV	143TC	60	B	4	K	F	25
Load %	0%	25%	50%	75%	100%	125%	150%			
Amps	0,61	0,64	0,83	1,07	1,36	1,67	1,99			
Torq ft/lbs	0	0,74	1,48	2,24	3,02	3,81	4,61			
RPM	0	1785	1770	1755	1740	1725	1710			
Eff	0	65,52	78,00	84,20	85,50	85,50	85,50			
PF	0	35,0	47	60	64,4	65,7	66,0			
	Locked Rotor	Pull-Up	Breakdown	Rated Load	Idle	Duty	S. F.	Ambient	Elevation	dBa @ 1M
Speed (RPM)	0	756	1440	1740	1800	Continuous	1,15	40°C	3,300 ft	61
Current (Amps)	12	10,2	7,1	1,36	0,612	VFD Rating: Meets MG1 parts 31.4.4.2				
Torque (ft-lbs)	9,06	7,70	9,36	3,02	0,0	CT	10:1	VT	20:1	

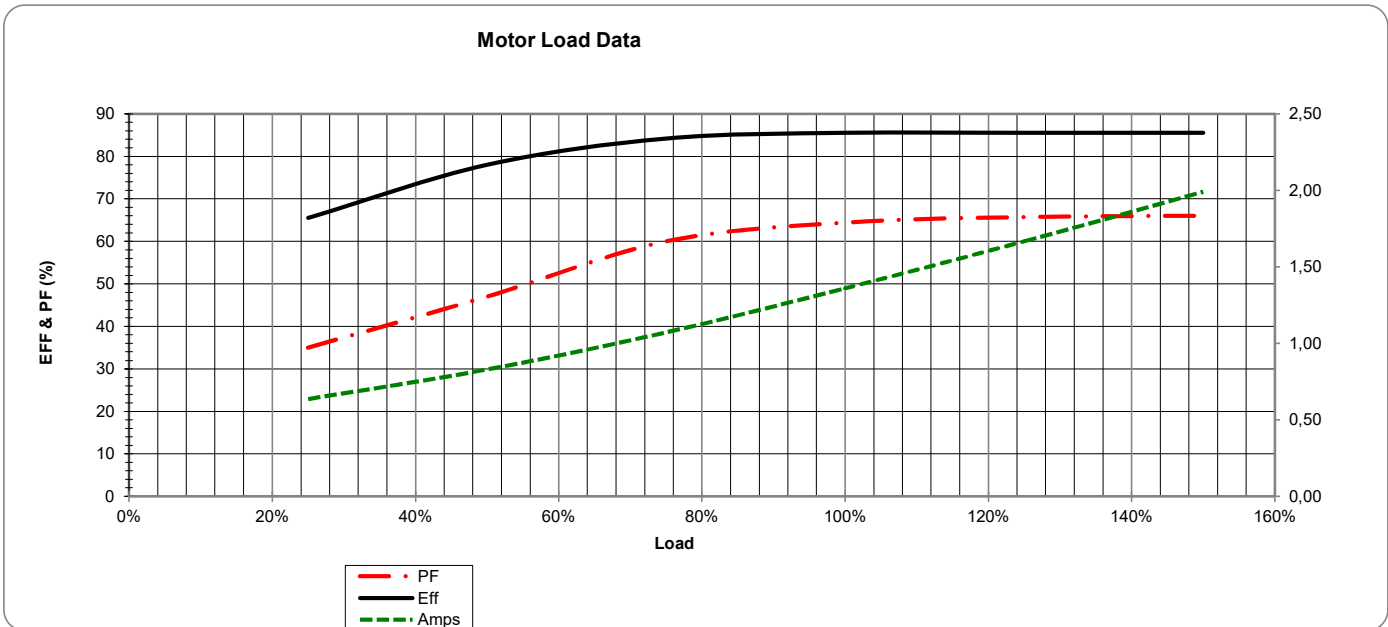
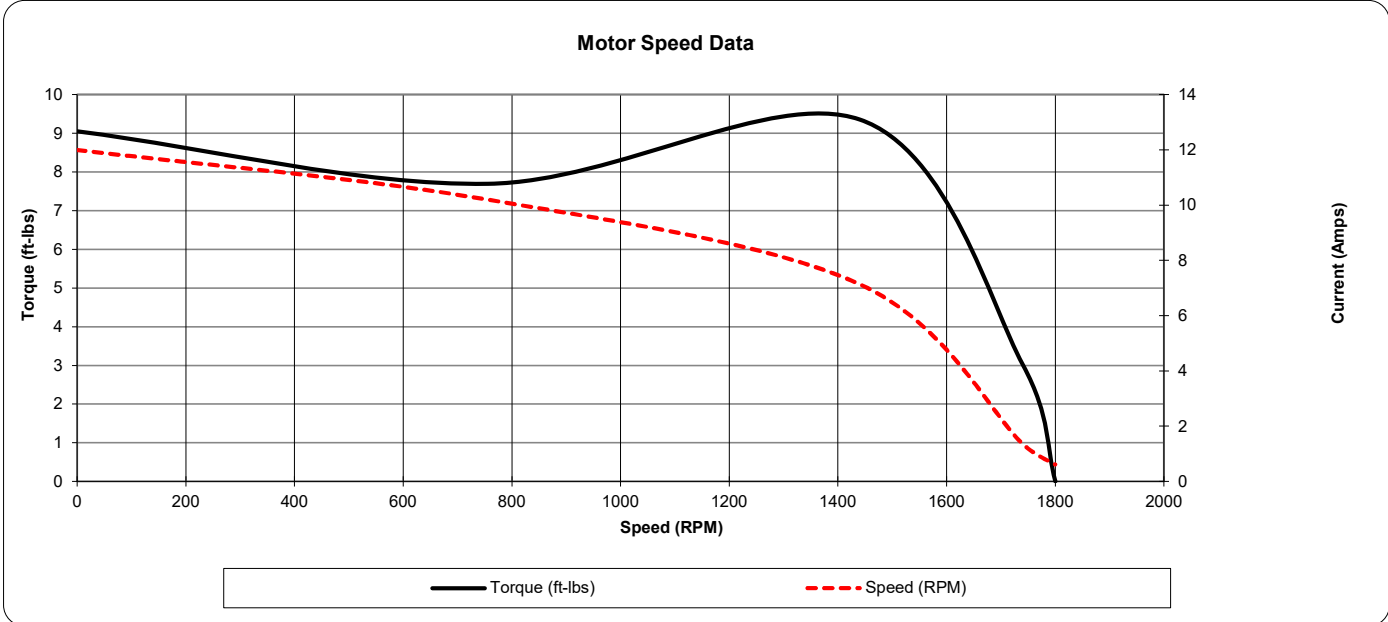

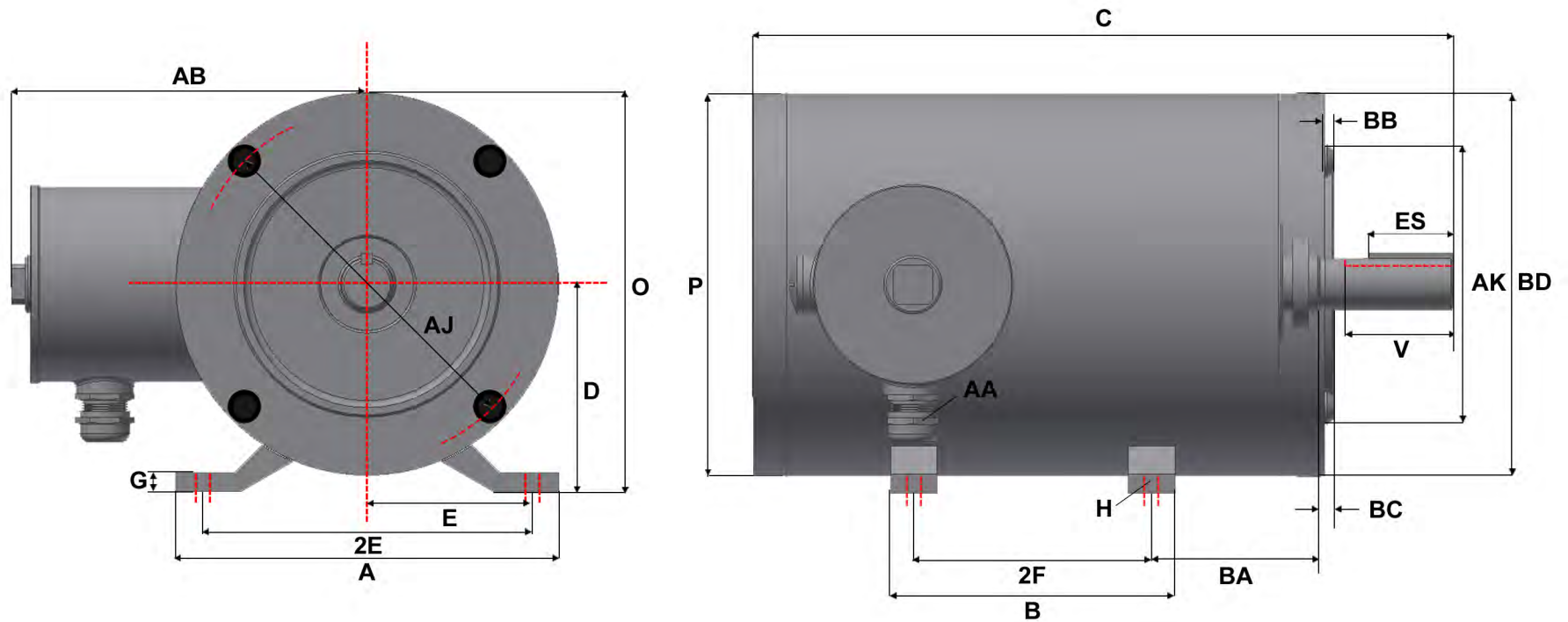

Version: 1WTI		Revised: 02-10-2020		HP	RPM	FRAME	ENCLOSURE	MQSP/MPSP-104TLNV				
Customer is responsible in determining that MEP product will fit/perform suitably in the intended application				1	1800	143TC	TENV					
A	B	C	D	E	2E	2F	G	H	O	P	R	S
6.30	4.80	10.84	3.50	2.75	5.50	4.00	0.315	0.34	6.73	6.45	0.771	0.188
T	U	V	AA	AB	AH	AJ	AK	BA	BB	BC	BD	ES
0.00	0.8750	1.496	1/2 NPT	5.95	2.12	5.875	4.50	2.75	0.16	0.12	6.45	1.41

PREMIUM DESIGN B NEMA 12-12

304 GRADE STAINLESS STEEL TENV TOTALLY ENCLOSED
NON-VENTILATED & TEFC TOTALLY ENCLOSED FAN COOLED

MaxMotion

Applications:

A durable and versatile motor design that can be base or flange mounted to equipment operating in wet and severe conditions, and where wash down duty and corrosive elements are found such as in the food processing, bottling and conveyor Industries.



Features:

Design - NEMA standard MG-1, Design B meets MG-1 Part 31

Agency listings and standard - Meets or exceeds MEPS (Minimum Efficiency Performance Standards) as described by US Department of Energy in docket 10CFR431 and Natural Resources Canada's Amendment 14. Also CSAus and CE Certified.

Service Factor - 1.15

Electrical Supply - At 60Hz: 575V and 230/460V dual rated and at 50Hz: 190/380.

Windings - Highest quality Enamel coated Corona resistant inverter duty magnet wire. VPI with additional dip and bake.

Insulation - Non hygroscopic class F with class B temperature rise

Voltage and frequency variation - +/- 10% as based on two voltage points of the motor being either 230 / 460 or 333 / 575

Bearing - Double sealed with Lithium grease -30 Deg to 180 Deg C

Enclosure Protection - Meets Ingress Protection Standard IP69K

Construction - Paint free with all 304 Stainless steel housing and shaft. Moisture proof sealant on all machined fits and shielded Viton type double lip seal . Four condensation plugs on each end shield for mounting flexibility.

Terminal Box - The round welded terminal box design comes completely encapsulated and offers two points of entry for easy access to the terminals. All while eliminating points where contaminants can build up, and maintaining the motors IP69K rating.

Inverter duty - Inverter Duty 10:1 Constant Torque, 20:1 Variable Torque

Nameplate - Permanently etched to stainless steel housing

Warranty - 24 Months



PREMIUM DESIGN B NEMA 12-12

304 GRADE STAINLESS STEEL TENV TOTALLY ENCLOSED
NON-VENTILATED & TEFC TOTALLY ENCLOSED FAN COOLED



HP	FL RPM	VOLTS	FRAME	CAT NO.	NOM EFF.	F.L. AMPS	CODE	WT (Lbs)	DE BRG	ODE BRG	"C" Dimension (Inch)
1/3	1725	575	56C	MPS-134L	73.4	0.44	K	28	6205	6205	9.8
	1725	230/460	56C	MQS-134L	73.4	1.1/.55	K	28	6205	6205	9.8
	1725	575	56C	MPS-134LFC	73.4	0.44	K	28	6205	6205	11.59
	1725	230/460	56C	MQS-134LFC	73.4	1.1/.55	K	28	6205	6205	11.59
1/2	3460	575	56C	MPS-122L	73.4	0.6	K	29	6205	6205	9.8
	3460	230/460	56C	MQS-122L	73.4	1.5/.75	K	29	6205	6205	9.8
	1725	575	56C	MPS-124L	78.2	0.688	K	31	6205	6205	9.8
	1725	230/460	56C	MQS-124L	78.2	1.72/.86	K	31	6205	6205	9.8
	1725	575	56C	MPS-124LFC	78.2	0.688	K	31	6205	6205	11.59
	1725	230/460	56C	MQS-124LFC	78.2	1.72/.86	K	31	6205	6205	11.59
	1155	575	56C	MPS-126L	75.3	0.75	K	31	6205	6205	9.8
	1155	230/460	56C	MQS-126L	75.3	1.8/.9	K	31	6205	6205	9.8
3/4	3460	575	56C	MPS-342L	76.8	0.96	K	33	6205	6205	10.78
	3460	230/460	56C	MQS-342L	76.8	2.4/1.2	K	33	6205	6205	10.78
	1725	575	56C	MPS-344L	81.1	0.96	K	33	6205	6205	10.78
	1725	230/460	56C	MQS-344L	81.1	2.4/1.2	K	33	6205	6205	10.78
	1725	575	56C	MPS-344LFC	81.1	0.96	K	33	6205	6205	12.57
	1725	230/460	56C	MQS-344LFC	81.1	2.4/1.2	K	33	6205	6205	12.57
	1155	575	56C	MPS-346L	81.7	1.04	K	34	6205	6205	10.78
	1155	230/460	56C	MQS-346L	81.7	2.6/1.3	K	34	6205	6205	10.78
1	3470	575	56C	MPSP-102L	77	1.12	K	35	6205	6205	12.57
	3470	230/460	56C	MQSP-102L	77	2.8/1.4	K	35	6205	6205	12.57
	3470	575	56C	MPSP-102LNV	77	1.12	K	35	6205	6205	10.78
	3470	230/460	56C	MQSP-102LNV	77	2.8/1.4	K	35	6205	6205	10.78
	1765	575	56C	MPSP-104L	86.7	1.216	K	36	6205	6205	12.57
	1765	230/460	56C	MQSP-104L	86.7	3.01/1.52	K	36	6205	6205	12.57
	1765	575	56C	MPSP-104LNV	86.7	1.216	K	36	6205	6205	10.78
	1765	230/460	56C	MQSP-104LNV	86.7	3.01/1.52	K	36	6205	6205	10.78
	1740	575	143TC	MPSP-104TL	85.5	1.36	K	36	6205	6205	12.63
	1740	230/460	143TC	MQSP-104TL	85.5	3.4/1.7	K	36	6205	6205	12.63
	1740	575	143TC	MPSP-104TLNV	85.5	1.36	K	36	6205	6205	10.84
	1740	230/460	143TC	MQSP-104TLNV	85.5	3.4/1.7	K	36	6205	6205	10.84
	1165	575	56C	MPSP-106L	82.5	1.4	K	36	6205	6205	12.57
	1165	230/460	56C	MQSP-106L	82.5	3.5/1.75	K	36	6205	6205	12.57
	1165	575	143TC	MPSP-106TL	82.5	1.4	K	42	6205	6205	13.81
	1165	230/460	143TC	MQSP-106TL	82.5	3.5/1.75	K	42	6205	6205	13.81
1.5	3470	575	56C	MPSP-152L	84	1.68	K	28	6205	6205	12.57
	3470	230/460	56C	MQSP-152L	84	4.2/2.1	K	28	6205	6205	12.57
	3470	575	56C	MPSP-152LNV	84	1.68	K	28	6205	6205	11.96
	3470	230/460	56C	MQSP-152LNV	84	4.2/2.1	K	28	6205	6205	11.96
	3480	575	143TC	MPSP-152TL	84	1.6	K	39	6205	6205	12.63
	3480	230/460	143TC	MQSP-152TL	84	2.21/1.92	K	39	6205	6205	12.63
	3480	575	143TC	MPSP-152TLNV	84	1.6	K	39	6205	6205	12.02
	3480	230/460	143TC	MQSP-152TLNV	84	2.21/1.92	K	39	6205	6205	12.02
	1750	575	56C	MPSP-154L	86.5	1.76	K	36	6205	6205	12.57
	1750	230/460	56C	MQSP-154L	86.5	4.4/2.2	K	36	6205	6205	12.57
	1750	575	56C	MPSP-154LNV	86.5	1.76	K	36	6205	6205	11.96
	1750	230/460	56C	MQSP-154LNV	86.5	4.4/2.2	K	36	6205	6205	11.96
	1740	575	145TC	MPSP-154TL	86.5	1.76	K	42	6205	6205	13.81
	1740	230/460	145TC	MQSP-154TL	86.5	4.4/2.2	K	42	6205	6205	13.81
	1740	575	145TC	MPSP-154TLNV	86.5	1.76	K	42	6205	6205	12.02
	1740	230/460	145TC	MQSP-154TLNV	86.5	4.4/2.2	K	42	6205	6205	12.02
	1150	575	56C	MPSP-156L	87.5	1.96	K	36	6205	6205	13.75
	1150	230/460	56C	MQSP-156L	87.5	4.9/2.45	K	36	6205	6205	13.75
	1170	575	182TC	MPSP-156TL	87.5	1.96	K	79	6308	6308	17.00
	1170	230/460	182TC	MQSP-156TL	87.5	4.9/2.45	K	79	6308	6308	17.00



PREMIUM DESIGN B NEMA 12-12

304 GRADE STAINLESS STEEL TENV TOTALLY ENCLOSED
NON-VENTILATED & TEFC TOTALLY ENCLOSED FAN COOLED



HP	FL RPM	VOLTS	FRAME	CAT NO.	NOM EFF.	F.L. AMPS	CODE	WT (Lbs)	DE BRG	ODE BRG	"C" Dimension (Inch)
2	3480	575	145TC	MPSP-202TL	85.5	1.92	K	46	6205	6205	13.81
	3480	230/460	145TC	MQSP-202TL	85.5	4.8-2.4	K	46	6205	6205	13.81
	3480	575	145TC	MPSP-202TLNV	85.5	1.92	K	46	6205	6205	13.81
	3480	230/460	145TC	MQSP-202TLNV	85.5	4.8-2.4	K	46	6205	6205	13.81
	1760	575	56C	MPSP-204L	86.5	2.16	K	36	6205	6205	13.75
	1760	230/460	56C	MQSP-204L	86.5	5.8/2.7	K	36	6205	6205	13.75
	1760	575	56C	MPSP-204LNV	86.5	2.16	K	40	6205	6205	13.75
	1760	230/460	56C	MQSP-204LNV	86.5	5.8/2.7	K	40	6205	6205	13.75
	1740	575	145TC	MPSP-204TL	86.5	2.16	K	49	6205	6205	13.81
	1740	230/460	145TC	MQSP-204TL	86.5	5.4/2.7	K	49	6205	6205	13.81
	1740	575	145TC	MPSP-204TLNV	86.5	2.16	K	54	6205	6205	13.81
	1740	230/460	145TC	MQSP-204TLNV	86.5	5.4/2.7	K	54	6205	6205	13.81
	1175	575	184TC	MPSP-206TL	88.5	2.48	L	95	6308	6308	17.00
	1175	230/460	184TC	MQSP-206TL	88.5	6.2/3.1	L	95	6308	6308	17.00
3	3535	575	184TC	MPSP-302TL	86.5	3.24	K	81	6308	6308	17.00
	3535	230/460	182TC	MQSP-302TL	86.5	8.1/4.05	K	81	6308	6308	17.00
	3535	575	184TC	MPSP-302TLNV	86.5	3.24	K	81	6308	6308	14.70
	3535	230/460	182TC	MQSP-302TLNV	86.5	8.1/4.05	K	81	6308	6308	14.70
	3535	575	145TC	MPSP-302TSL	86.5	3.24	K	81	6205	6205	15.58
	3535	230/460	145TC	MQSP-302TSL	86.5	8.1/4.05	K	81	6205	6205	15.58
	1765	575	182TC	MPSP-304TL	89.5	3.2	K	89	6308	6306	17.00
	1765	230/460	182TC	MQSP-304TL	89.5	8/4	K	89	6308	6306	17.00
	1760	575	56C	MPSP-304TL-56C	89.5	3.2	K	63	6205	6205	15.52
	1760	230/460	56C	MQSP-304TL-56C	89.5	8/4	K	63	6205	6205	15.52
	1760	575	182TC	MPSP-304TLNV	89.5	3.2	K	98	6205	6205	14.70
	1760	230/460	182TC	MQSP-304TLNV	89.5	8/4	K	98	6205	6205	14.70
	1765	575	145TC	MPSP-304TSL	89.5	3.2	K	78	6308	6306	15.58
	1765	230/460	145TC	MQSP-304TSL	89.5	8/4	K	78	6308	6306	15.58
1765	575	145TC	MPSP-304TSL-F0	89.5	3.2	K	78	6308	6306	15.58	
1175	575	213TC	MPSP-306TL	89.5	3.44	K	110	6308	6208	20.70	
1175	230/460	213TC	MQSP-306TL	89.5	8.6/4.3	K	110	6308	6208	20.70	
5	3525	575	184TC	MPSP-502TL	88.5	4.88	J	95	6308	6306	17.00
	3525	230/460	184TC	MQSP-502TL	88.5	12.2/6.1	J	95	6308	6306	17.00
	1765	575	184TC	MPSP-504TL	89.5	5	J	104	6308	6306	17.00
	1765	230/460	184TC	MQSP-504TL	89.5	12.5/6.25	J	104	6308	6306	17.00
	1175	575	215TC	MPSP-506TL	89.5	5.44	J	171	6308	6208	21.50
	1175	230/460	215TC	MQSP-506TL	89.5	13.6/6.8	J	171	6308	6208	21.50
7	3520	575	213TC	MPSP-702TL	89.5	7.52	H	110	6308	6208	20.70
	3520	230/460	213TC	MQSP-702TL	89.5	18.8/9.4	H	110	6308	6208	20.70
	1755	575	213TC	MPSP-704TL	91.7	7.44	H	163	6308	6208	20.70
	1755	230/460	213TC	MQSP-704TL	91.7	18.6/9.3	H	163	6308	6208	20.70
10	3525	575	215TC	MPSP-1002TL	90.2	9.76	H	175	6308	6208	20.70
	3525	230/460	215TC	MQSP-1002TL	90.2	24.4/12.2	H	175	6308	6208	20.70
	1760	575	215TC	MPSP-1004TL	91.7	9.79	H	200	6308	6208	21.50
	1760	230/460	215TC	MQSP-1004TL	91.7	24.4/12.2	H	200	6308	6208	21.50
15	3530	575	254TC	MPSP-1502TL	92.4	14.8	G	286	6309	6309	23.20
	3530	230/460	254TC	MQSP-1502TL	92.4	37/18.5	G	286	6309	6309	23.20
	1765	575	254TC	MPSP-1504TL	92.4	14.4	G	286	6309	6309	23.20
	1765	230/460	254TC	MQSP-1504TL	92.4	36/18	G	286	6309	6309	23.20
20	3530	575	256TC	MPSP-2002TL	93	18.4	G	352	6309	6309	24.80
	3530	230/460	256TC	MQSP-2002TL	93	46/23	G	352	6309	6309	24.80
	1765	575	256TC	MPSP-2004TL	93	19.6	G	352	6309	6309	24.80
	1765	230/460	256TC	MQSP-2004TL	93	49/24.4	G	352	6309	6309	24.80



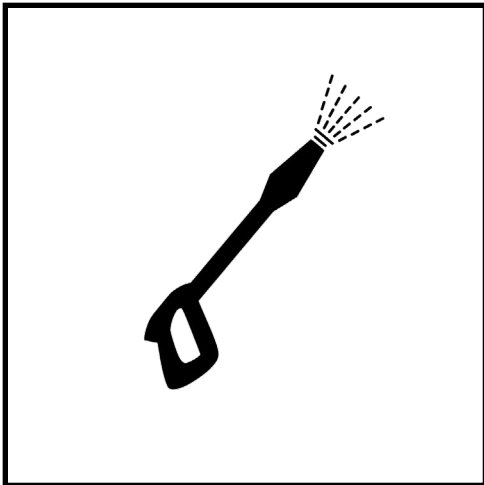

When this power wash icon is displayed, this means the fixture is rated IP69K.

What is IP69K?

The IP69K rating is for applications where high pressure and high temperature wash-down are used to sanitize equipment. The IP69K test specification was initially developed for road vehicles, especially those that need regular intensive cleaning (dump trucks, cement mixers, etc.), but has been widely adopted in the Food & Beverage industries as a test of products to withstand sanitary washdown.

More specifics on IP69K

In applications where devices were regularly exposed to high-pressure or high temperature wash downs, the highest ratings of IP68 was sometimes found to be insufficient. Therefore, a special rating was created by ISO to test this intensive cleaning. In the IEC 60529 rating system, IP6 refers to the product's ability to resist ingress of dust. The 69K refers to the product's ability to resist ingress of high temperature (steam) / high pressure water.

Only if the device passes this test can it be considered IP69K rated and used in harsh environments with high pressure / steam cleaning.

Testing procedure per ISO 20653:

(depicted in image to right)

- A spray nozzle that is fed with 80°C water at 80–100 bar (~1160-1450) and a flow rate of 14–16 L/min.
- The nozzle is held 10-15cm from the tested device at angles of 0°, 30°, 60° and 90° for 30 seconds each.
- The test device sits on a turntable that rotates once every 12 seconds.

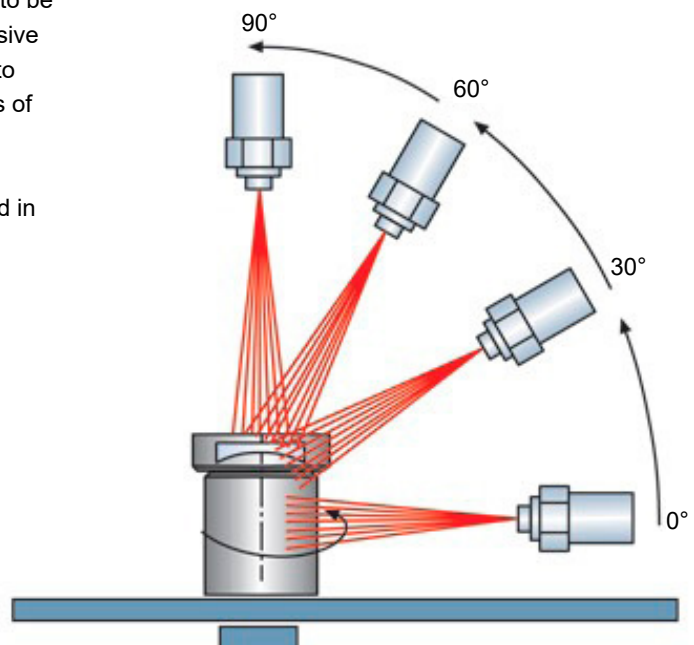

IP68, IP69 and IP69K - The facts

Even though you can do an internet search for IP69, it is important to note that there is no IP69 rating. The IP chart goes from IP68 to IP69K. In addition, just because IP69K is a higher number does not mean the coverage or rating is higher or better than IP68. In fact, IP68 and IP69K are very different ratings. While both share the same first digit "6" which is protection against the ingress of solid objects and are rated as dust tight, that is where the similarity ends. IP68 is rated for prolonged immersion in water, IP69K as noted above involves pressure washing at high temperatures.